

# HIGH SPEED Silicon Controlled Rectifier

**C158 - C159**

**1200 Volts**

**110 A RMS**

**AMPLIFYING  
GATE**

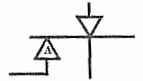

The General Electric C158 and C159 Silicon Controlled Rectifiers are designed for power switching at high frequencies. These are all-diffused Pic-Pac devices employing the field-proven amplifying gate.

**FEATURES:**

- High di/dt ratings.
- High dv/dt capability with selections available.
- Excellent surge and I<sup>2</sup>t ratings providing easy fusing.
- Guaranteed maximum turn-off time with selections available.
- Rugged hermetic package with long creepage path.

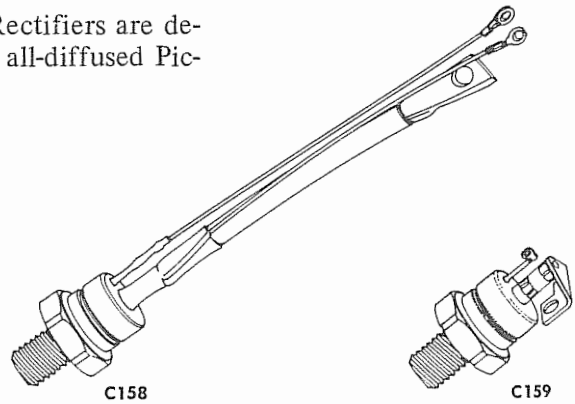

## HIGH FREQUENCY CURRENT RATING

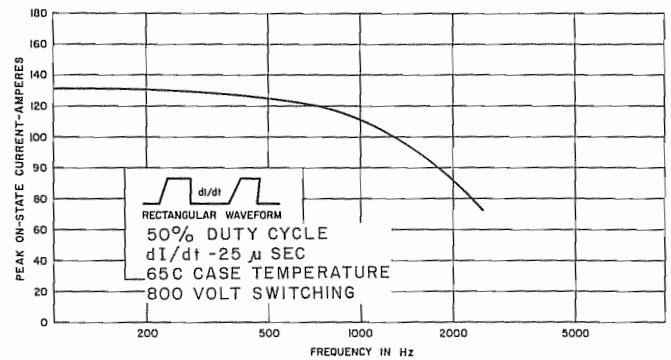
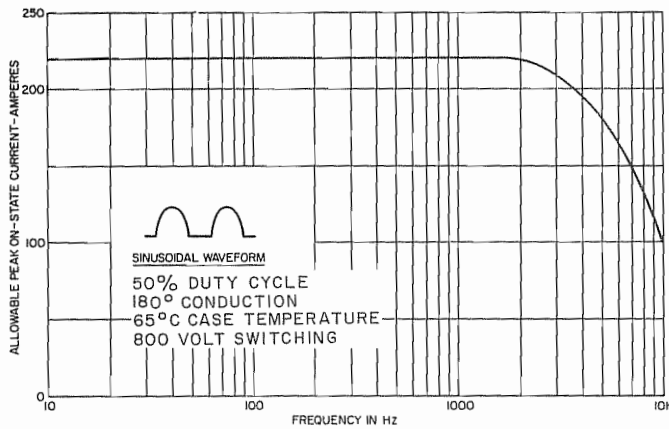

## MAXIMUM ALLOWABLE RATINGS

TYPES	REPETITIVE PEAK OFF-STATE VOLTAGE, $V_{DRM}^1$ $T_J = -40^\circ\text{C to } +125^\circ\text{C}$	REPETITIVE PEAK REVERSE VOLTAGE, $V_{RRM}^1$ $T_J = -40^\circ\text{C to } +125^\circ\text{C}$	NON-REPETITIVE PEAK REVERSE VOLTAGE, $V_{RSM}^1$ $T_J = +125^\circ\text{C}$
C158E, C159E	500 Volts	500 Volts	600 Volts
C158M, C159M	600	600	720
C158S, C159S	700	700	840
C158N, C159N	800	800	960
C158T, C159T	900	900	1080
C158P, C159P	1000	1000	1200
C158PA, C159PA	1100	1100	1300
C158PB, C159PB	1200	1200	1400

<sup>1</sup> Half sinewave waveform, 10 ms max. pulse width.

RMS On-State Current, $I_{T(RMS)}$ . . . . .	110 Amperes
Peak One Cycle Surge (Non-Repetitive) On-State Current, $I_{TSM}$ (60 Hz) . . . . .	1600 Amperes
Peak One Cycle Surge (Non-Repetitive) On-State Current, $I_{TSM}$ (50 Hz) . . . . .	1500 Amperes
$I^2t$ (for fusing) for times $\geq 1.5$ milliseconds . . . . .	5,200 (RMS Ampere) <sup>2</sup> Seconds
$I^2t$ (for fusing) for times $\geq 8.3$ milliseconds . . . . .	10,500 (RMS Ampere) <sup>2</sup> Seconds
Critical Rate-of-Rise of On-State Current, Non-Repetitive. . . . .	800 A/ $\mu$ s †
Critical Rate-of-Rise of On-State Current, Repetitive . . . . .	500 A/ $\mu$ s †
Average Gate Power Dissipation, $P_{G(AV)}$ . . . . .	2 Watts
Storage Temperature, $T_{stg}$ . . . . .	-40°C to +150°C
Operating Temperature, $T_J$ . . . . .	-40°C to +125°C
Stud Torque . . . . .	150 Lb.-In. (Max.), 125 Lb.-In. (Min.) 17 N-m (Max.), 14 N-m (Min.)

†di/dt ratings established in accordance with EIA-NEMA Standard RS-397, Section 5.2.2.6 for conditions of max. rated  $V_{DRM}$ ; 20 volts, 20 ohms gate trigger source with 0.5  $\mu$ s short circuit trigger current rise time.

**CHARACTERISTICS**

TEST	SYMBOL	MIN.	TYP.	MAX.	UNITS	TEST CONDITION
Repetitive Peak Reverse and Off-State Current	$I_{RRM}$ and $I_{DRM}$				mA	$T_J = +25^\circ C$ $V_{DRM} = V_{RRM} =$
C158E, C159E		—	3	10		500 Volts Peak
C158M, C159M		—	3	10		600
C158S, C159S		—	3	10		700
C158N, C159N		—	3	10		800
C158T, C159T		—	3	9		900
C158P, C159P		—	3	7		1000
C158PA,C159PA		—	3	7		1100
C158PB,C159PB		—	3	7		1200
Repetitive Peak Reverse and Off-State Current	$I_{RRM}$ and $I_{DRM}$				mA	$T_J = 125^\circ C$ $V_{DRM} = V_{RRM} =$
C158E, C159E		—	12	15		500 Volts Peak
C158M, C159M		—	12	15		600
C158S, C159S		—	12	15		700
C158N, C159N		—	12	15		800
C158T, C159T		—	12	15		900
C158P, C159P		—	12	15		1000
C158PA,C159PA		—	12	17		1100
C158PB,C159PB		—	12	18		1200
Thermal Resistance	$R_{\theta JC}$	—	.2	.3	°C/Watt	Junction-to-Case
Critical Rate-of-Rise of Off-State Voltage (Higher values may cause device switching)	dv/dt	200	500	—	V/ $\mu$ sec	$T_J = +125^\circ C$ , Gate Open. $V_{DRM} =$ Rated Linear or Exponential Rising Waveform. Exponential dv/dt = $\frac{V_{DRM} (.632)}{\tau}$
Higher minimum dv/dt selections available – consult factory.						
Holding Current	$I_H$	—	100	—	mAdc	$T_C = +25^\circ C$ , Anode Supply = 25 Vdc. Initial On-State Current = 2 Amps.
DC Gate Trigger Current	$I_{GT}$	—	80	150	mAdc	$T_C = +25^\circ C$ , $V_D = 6$ Vdc, $R_L = 3$ Ohms
		—	150	300		$T_C = -40^\circ C$ , $V_D = 6$ Vdc, $R_L = 3$ Ohms
		—	30	125		$T_C = +125^\circ C$ , $V_D = 6$ Vdc, $R_L = 3$ Ohms

## CHARACTERISTICS (Continued)

TEST	SYMBOL	MIN.	TYP.	MAX.	UNITS	TEST CONDITION
DC Gate Trigger Voltage	$V_{GT}$	—	3	5	Vdc	$T_C = -40^\circ\text{C}$ to $0^\circ\text{C}$ , $V_D = 6\text{Vdc}$ , $R_L = 3\text{ Ohms}$
		—	1.25	3.0		$T_C = 0^\circ\text{C}$ to $125^\circ\text{C}$ , $V_D = 6\text{Vdc}$ , $R_L = 3\text{ Ohms}$
		0.15	—	—		$T_C = 125^\circ\text{C}$ , $V_{DRM}$ , $R_L = 1000\text{ Ohms}$
Peak On-State Voltage	$V_{TM}$	—	2.8	3.5	Volts	$T_C = +25^\circ\text{C}$ , $I_{TM} = 500\text{ Amps. Peak.}$ Duty Cycle $\leq .01\%$ .
Turn-On Delay Time	$t_d$	—	0.5	—	$\mu\text{sec}$	$T_C = +25^\circ\text{C}$ , $I_T = 50\text{ Adc}$ , $V_{DRM}$ , Gate Supply: 20 Volt Open Circuit, 20 Ohm, 0.1 $\mu\text{sec}$ max. Rise Time, ††, †††
Conventional Circuit Commutated Turn-Off Time (with Reverse Voltage)	$t_q$	—	20	†	$\mu\text{sec}$	(1) $T_C = +125^\circ\text{C}$ (2) $I_T = 150\text{ Amps.}$ (3) $V_R = 50\text{ Volts Min.}$ (4) $V_{DRM}$ (Reapplied) (5) Rate-of-Rise of Reapplied Off-State Voltage = $20\text{ V}/\mu\text{sec}$ (Linear) (6) Commutation $di/dt = 5\text{ Amps}/\mu\text{sec}$ (7) Repetition Rate = 1 pps. (8) Gate Bias During Turn-Off Interval = 0 Volts, 100 Ohms
		—	25	40	$\mu\text{sec}$	(1) $T_C = +125^\circ\text{C}$ (2) $I_T = 150\text{ Amps.}$ (3) $V_R = 50\text{ Volts Min.}$ (4) $V_{DRM}$ (Reapplied) (5) Rate-of-Rise of Reapplied Off-State Voltage = $200\text{ V}/\mu\text{sec}$ (Linear) (6) Commutation $di/dt = 5\text{ Amps}/\mu\text{sec}$ (7) Repetition Rate = 1 pps. (8) Gate Bias During Turn-Off Interval = 0 Volts, 100 Ohms
Conventional Circuit Commutated Turn-Off Time (with Feedback Diode)	$t_q(\text{diode})$	—	40	†	$\mu\text{sec}$	(1) $T_C = +125^\circ\text{C}$ (2) $I_T = 150\text{ Amps.}$ (3) $V_R = 1\text{ Volt}$ (4) $V_{DRM}$ (Reapplied) (5) Rate-of-Rise of Reapplied Off-State Voltage = $200\text{ V}/\mu\text{sec}$ (Linear) (6) Commutation $di/dt = 5\text{ Amps}/\mu\text{sec}$ (7) Repetition Rate = 1 pps. (8) Gate Bias During Turn-Off Interval = 0 Volts, 100 Ohms

†Consult factory for specified maximum Turn-Off Time.

††Delay Time may increase significantly as the gate drive approaches the  $I_{GT}$  of the Device Under Test.

†††Current rise time as measured with a current probe, or voltage rise time across a non-inductive resistor.

# SINEWAVE CURRENT RATING DATA

C158, C159

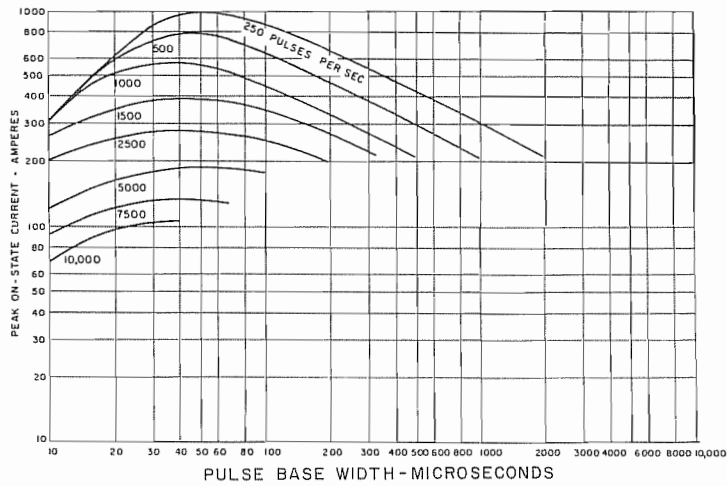

1. MAXIMUM ALLOWABLE PEAK ON-STATE CURRENT VS. PULSE WIDTH ( $T_C = 65^\circ C$ )

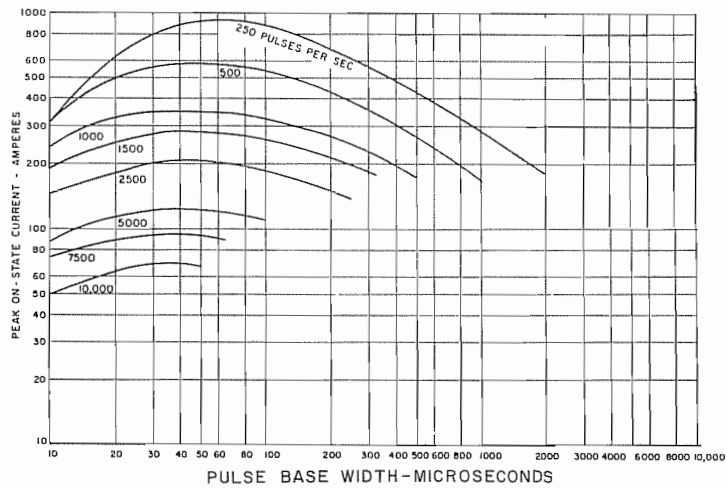

2. MAXIMUM ALLOWABLE PEAK ON-STATE CURRENT VS. PULSE WIDTH ( $T_C = 90^\circ C$ )

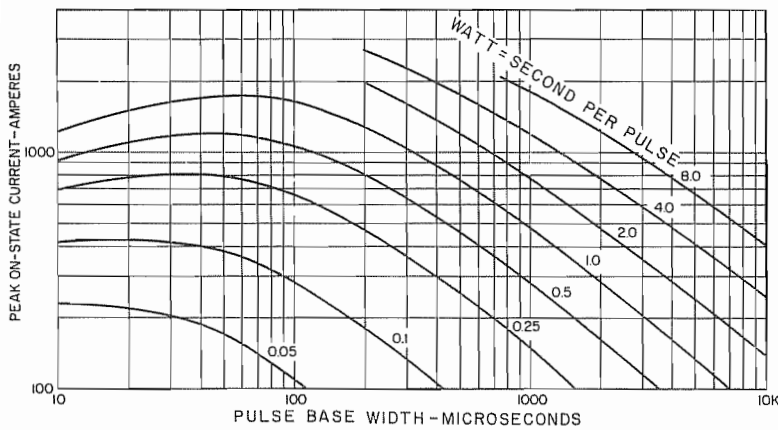

3. ENERGY PER PULSE FOR SINUSOIDAL PULSES

**NOTES:**

(Pertaining to Sine and Rectangular Wave Current Ratings)

1. Switching Voltage = 800 Volts.
2. Maximum ckt.  $dv/dt = 200 \text{ Volts}/\mu\text{sec}$
3. Reverse Voltage Applied =  $V_R \leq 800 \text{ V}$ .
4. Required Gate Drive:  
 20 volts, 65 ohms, 1  $\mu\text{sec}$  rise time for less than 100 amps/ $\mu\text{sec}$   
 20 volts, 20 ohms, .5  $\mu\text{sec}$  rise time for greater than 100 amps/ $\mu\text{sec}$ .
5. RC Snubber ckt. = 0.25  $\mu\text{f}$ , 5 $\Omega$
6. Max. energy dissipated during reverse recovery to be 15% of total W-S/P shown in chart 5 or 0.03 W-S/P whichever is least.
7. Values of W-S/P are for  $T_j = 125^\circ C$ .

RECTANGULAR WAVE CURRENT RATING DATA

DUTY CYCLE - 50%

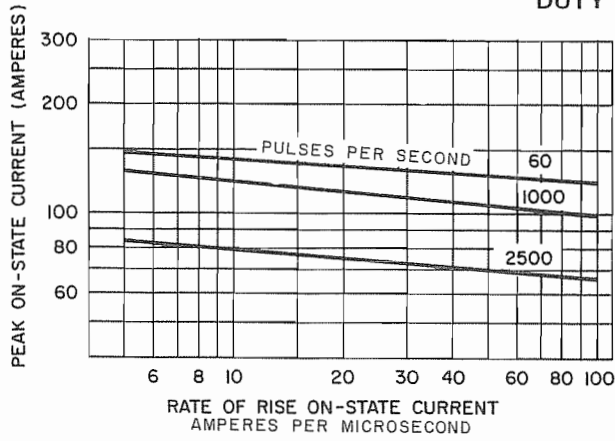

4. MAXIMUM ALLOWABLE PEAK ON-STATE CURRENT VS.  $di/dt$  ( $T_C = 65^\circ C$ )

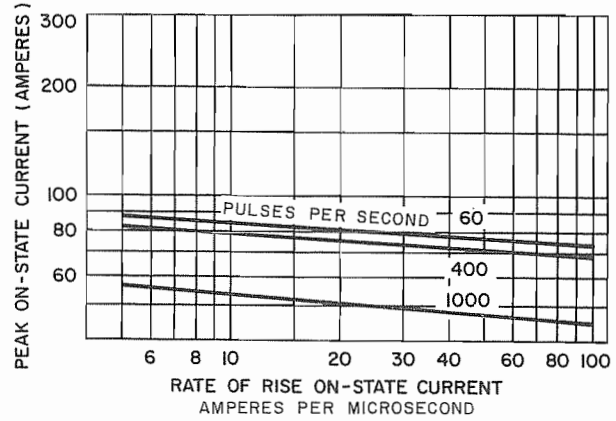

5. MAXIMUM ALLOWABLE PEAK ON-STATE CURRENT VS.  $di/dt$  ( $T_C = 90^\circ C$ )

DUTY CYCLE - 25%

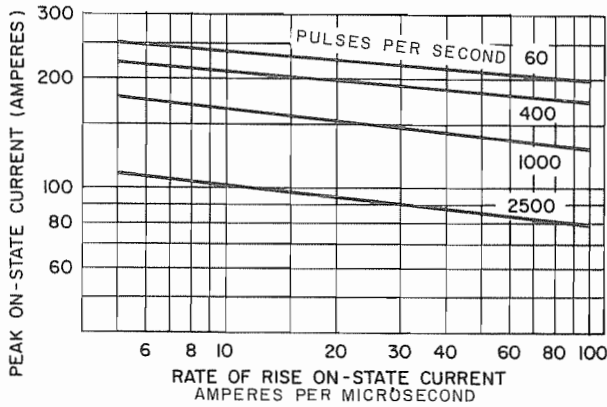

6. MAXIMUM ALLOWABLE PEAK ON-STATE CURRENT VS.  $di/dt$  ( $T_C = 65^\circ C$ )

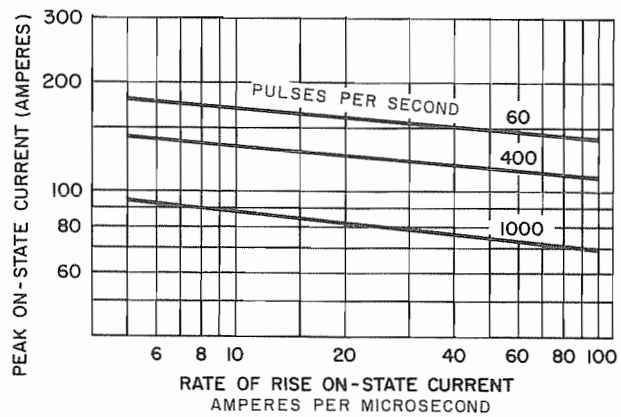

7. MAXIMUM ALLOWABLE PEAK ON-STATE CURRENT VS.  $di/dt$  ( $T_C = 90^\circ C$ )

WATT-SECOND PER PULSE

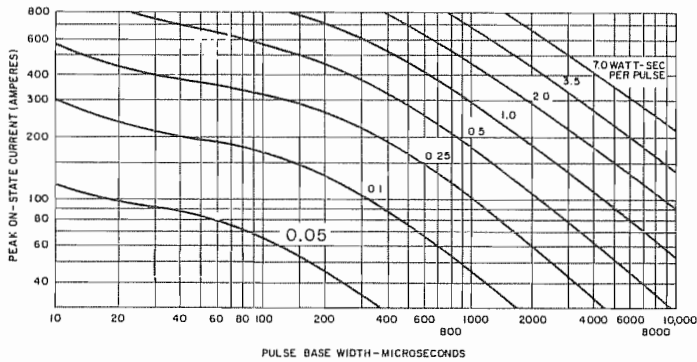

8. ENERGY PER PULSE VS. PEAK CURRENT AND PULSE WIDTH ( $di/dt = 100 A/\mu sec$ )

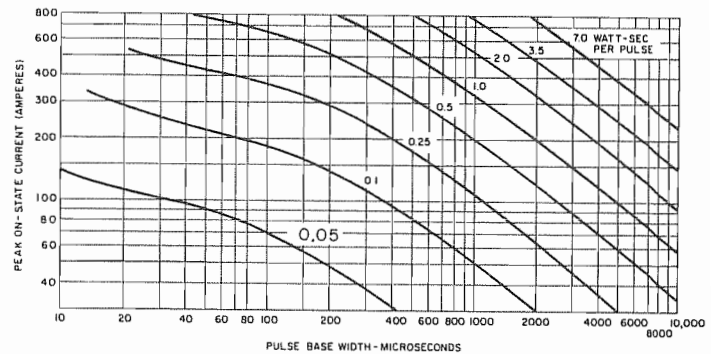

9. ENERGY PER PULSE VS. PEAK CURRENT AND PULSE WIDTH ( $di/dt = 25 A/\mu sec$ )

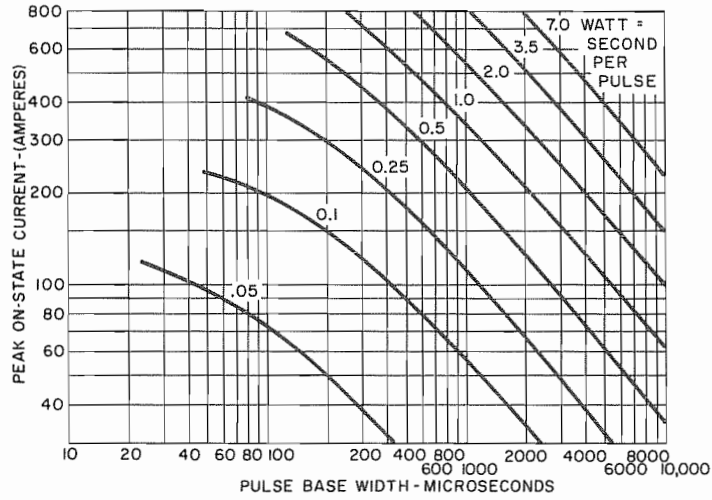

10. ENERGY PER PULSE VS. PEAK CURRENT AND PULSE WIDTH ( $di/dt = 5 \text{ A}/\mu\text{sec}$ )

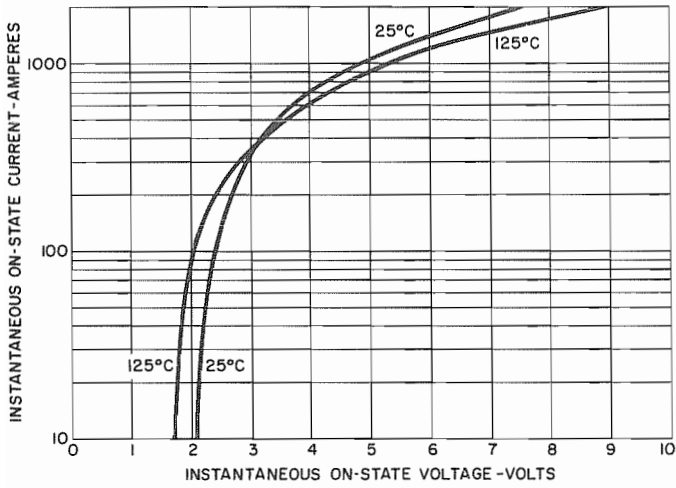

11. MAXIMUM ON-STATE CHARACTERISTICS

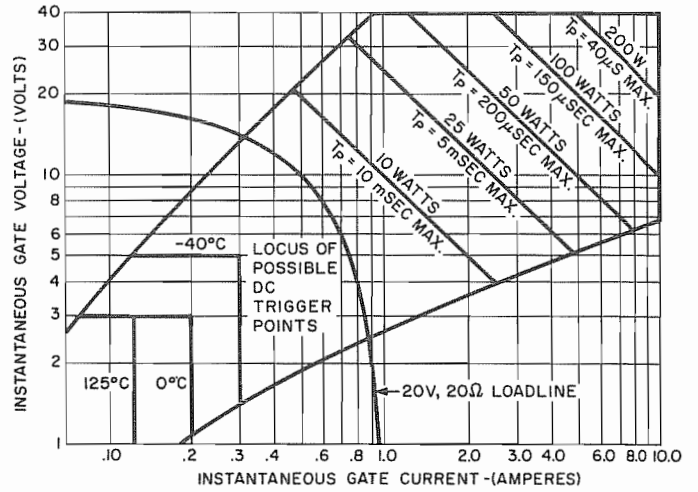

12. GATE TRIGGER CHARACTERISTICS AND POWER RATINGS

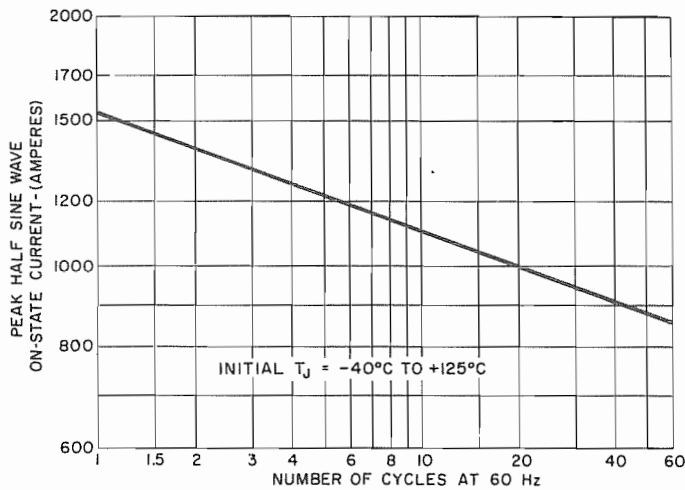

13. SURGE (NON-REPETITIVE) ON-STATE CURRENT

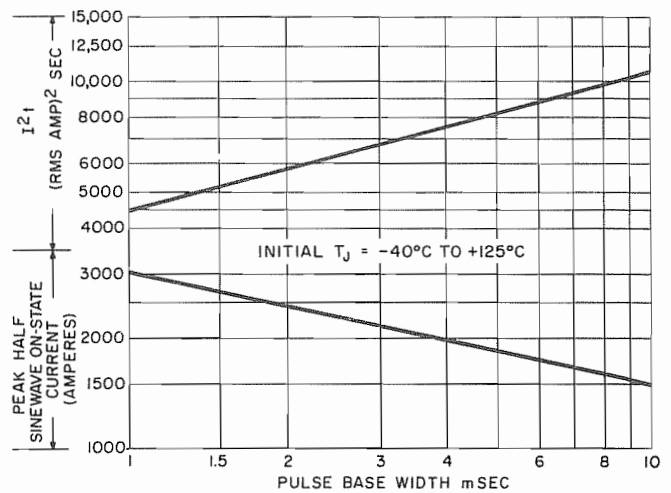

14. SUB-CYCLE SURGE (NON-REPETITIVE) ON-STATE CURRENT AND  $I^2t$  RATING

LOW FREQUENCY DATA

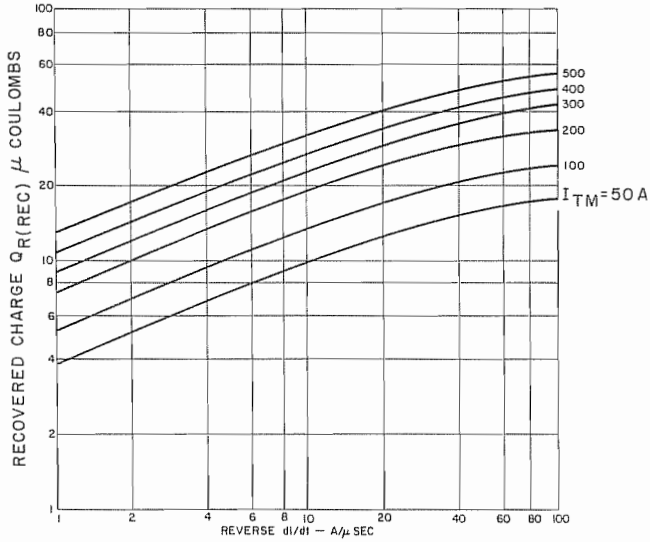

15. TYPICAL RECOVERED CHARGE (125°C) SINEWAVE CURRENT WAVEFORM

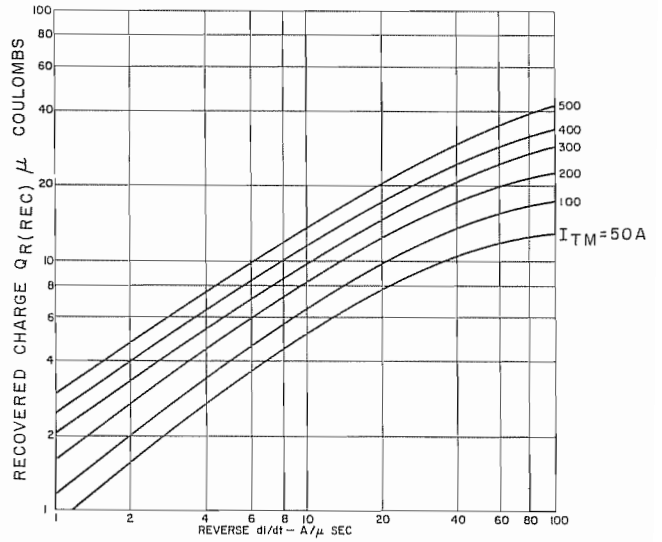

16. TYPICAL RECOVERED CHARGE (25°C) SINEWAVE CURRENT WAVEFORM

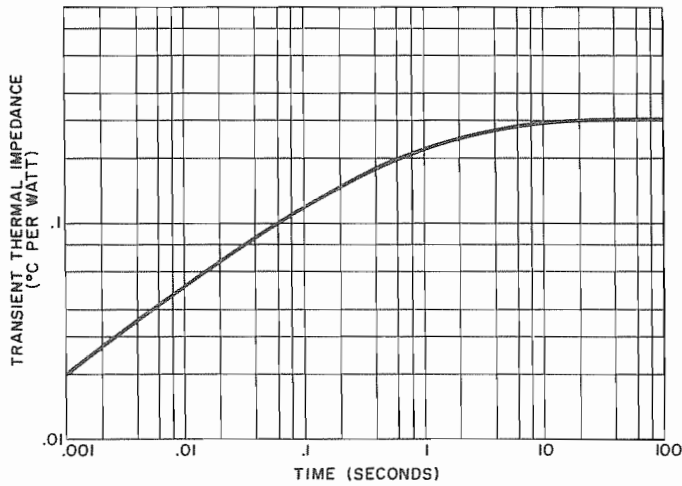

17. TRANSIENT THERMAL IMPEDANCE — JUNCTION-TO-CASE

OUTLINE DRAWINGS

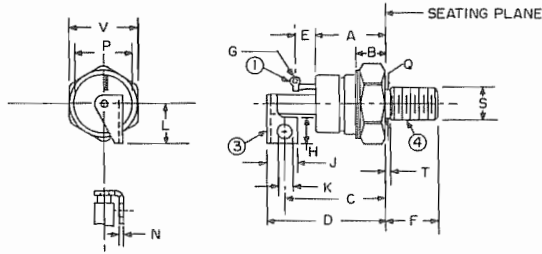

MODEL	TERMINAL ①	TERMINAL ③	TERMINAL ④	S THREAD SIZE
C159	GATE	CATHODE +	ANODE -	1/2-20 UNF-2A

- NOTES:
- ONE NUT AND ONE LOCKWASHER SUPPLIED WITH EACH UNIT. MATERIAL OF HARDWARE IS STEEL, CAD PLATED.
  - "T" DIM. IS AREA OF UNTHREADED PORTION. COMPLETE THDS. ARE WITHIN 2.5 THREADS OF SEATING PLANE.
  - ANGULAR ORIENTATION OF TERMINALS IS UNDEFINED.

SYM	INCHES		METRIC MM		SYM.	INCHES		METRIC MM		NOTES
	MIN.	MAX.	MIN.	MAX.		MIN.	MAX.	MIN.	MAX.	
A	1.020	1.140	25.90	28.96	L	.590	.640	14.98	16.26	
B	.390	.500	9.90	12.70						
C	1.460	REF.	7.92	REF.	N	.058	.070	1.47	1.78	
D	1.660	1.800	42.16	45.72						
E	.312	REF.	7.92	REF.	P	.840	.910	21.33	23.11	
F	.797	.827	20.24	21.01						
G	.060	.075	1.52	1.91	Q	.425	.499	10.79	12.67	
H	.385	.415	9.77	10.54	T	—	.060	—	1.52	2
J	.445	.485	11.30	12.32	V	1.052	1.063	26.72	27.00	
K	.198	.212	5.02	5.38						

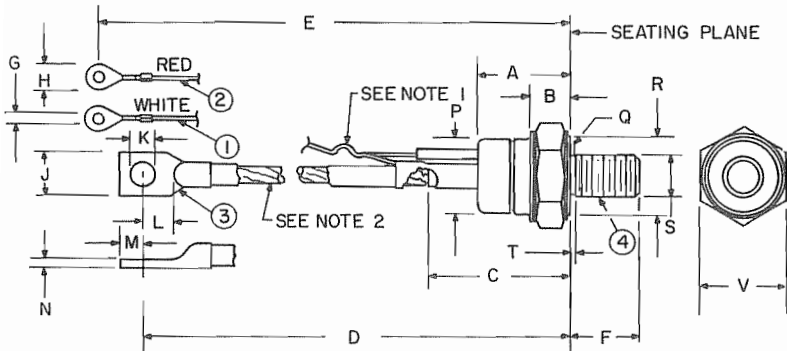

MODEL	TERMINAL ①	TERMINAL ②	TERMINAL ③	TERMINAL ④	S THREAD SIZE
C158	GATE	AUX CATHODE +	CATHODE +	ANODE -	1/2 20UNF-2A

- NOTES:
- GATE & AUX. CATHODE LEADS SUPPLIED LIGHTLY TWISTED TOGETHER.
  - FLEXIBLE COPPER LEAD.
  - ONE NUT AND ONE LOCKWASHER SUPPLIED WITH EACH UNIT. MATERIAL OF HARDWARE IS STEEL, CAD PLATED.
  - "R" DIM. IS DIA. OF EFFECTIVE SEATING AREA.
  - "T" DIM. IS AREA OF UNTHREADED PORTION. COMPLETE THDS. ARE WITHIN 2.5 THREADS OF SEATING PLANE.
  - ANGULAR ORIENTATION OF TERMINALS IS UNDEFINED.

SYM	INCHES		METRIC MM		SYM.	INCHES		METRIC MM		NOTES
	MIN.	MAX.	MIN.	MAX.		MIN.	MAX.	MIN.	MAX.	
A	1.020	1.140	25.90	28.96	L	.330	—	8.38	—	
B	.390	.500	9.90	12.70	M	.275	.325	6.98	8.26	
C	1.570	1.750	39.87	44.45	N	.065	.095	1.65	2.41	
D	6.000	6.390	152.40	162.31	P	.840	.910	21.33	23.11	
E	6.850	7.500	173.99	190.50	Q	.425	.499	10.79	12.67	
F	.797	.827	20.24	21.01	R	.920	—	23.36	—	4
G	.140	.150	3.55	3.81	T	—	.060	—	1.57	5
H	—	.300	—	7.62						
J	.500	.610	12.70	15.49	V	1.052	1.063	26.72	27.00	
K	.260	.281	6.60	7.14						

